

Upholstered Valance Installation Instructions

Brackets: Determine which brackets came with your valance.

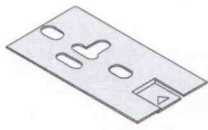

Inside Mount or Shallow Mount with 1 1/2", 2", or 2 1/2" Returns

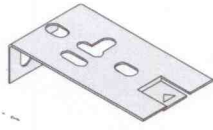

Outside Mount with 3" Returns

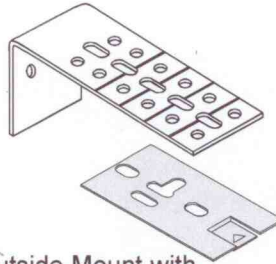

Outside Mount with 4", 5" or 6" Returns



Corner Brace for Valance Returns

Valance Width	# Brackets
≤ 40"	2
>40" to 72"	3
>72" to 84"	4
>84"	5

Step 1: Valance Assembly

Before installing, assemble your valance. Fold returns and insert the corner brace into the white plastic extrusion to secure.

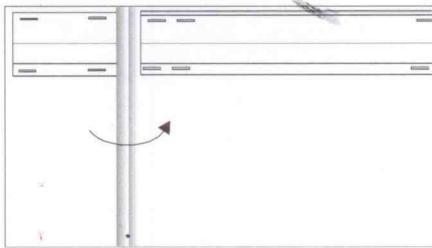

Fold return

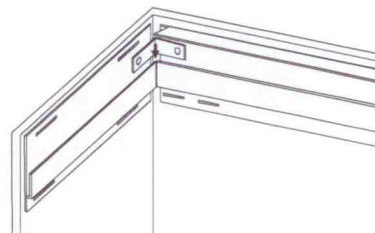

Secure return with corner brace

Step 2: Assemble Bracket (if required) & Determine Bracket Placement

If your valance requires the 2 piece bracket, bolt the pieces together at the correct position for your return size (images at right).

Slide the installation brackets onto the valance as shown.

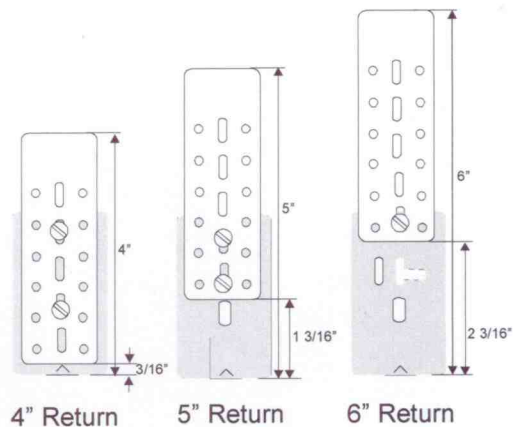
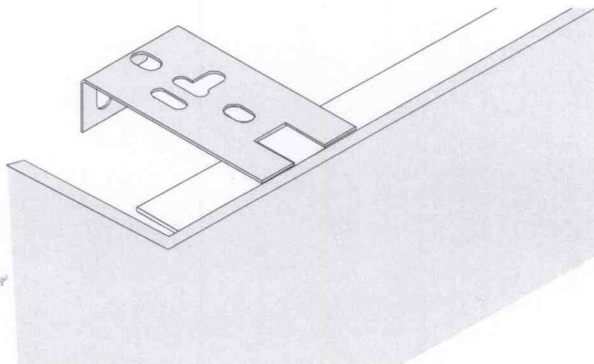

Hold the valance at the desired location and mark the bracket height for an outside mount or depth for an inside mount.

Step 3: Bracket Installation

Install your brackets either inside, outside or nested with your shade brackets.

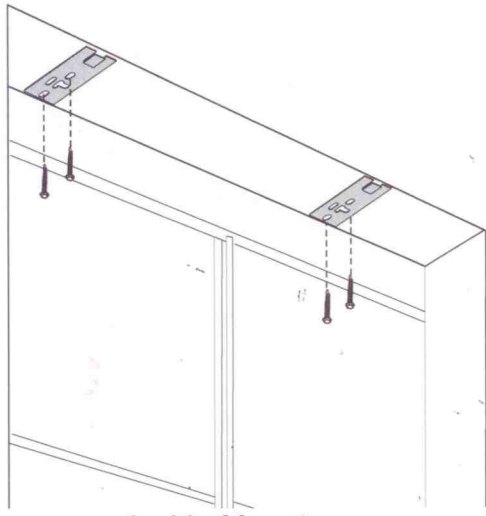

Inside Mount

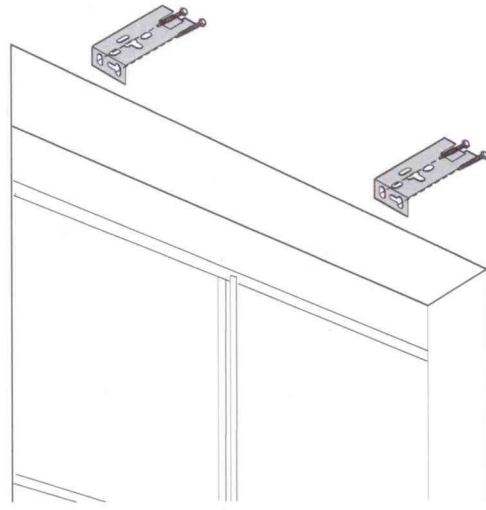

Outside Mount

It is often possible to nest the valance bracket with your window treatment bracket. Check to make sure that the holes will align before installing in this manner.

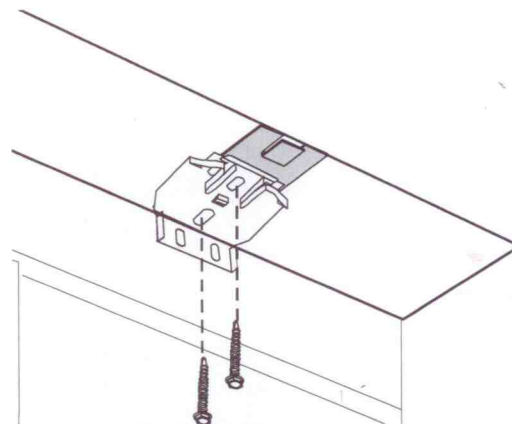

Nesting Window Treatment Brackets with the Valance Brackets

Step 4: Valance Installation

Center the valance and press it onto the valance brackets. Be sure you press firmly to secure it in place.

